

DOMINA PLUS B

Water Steam Sterilizer

User Manual

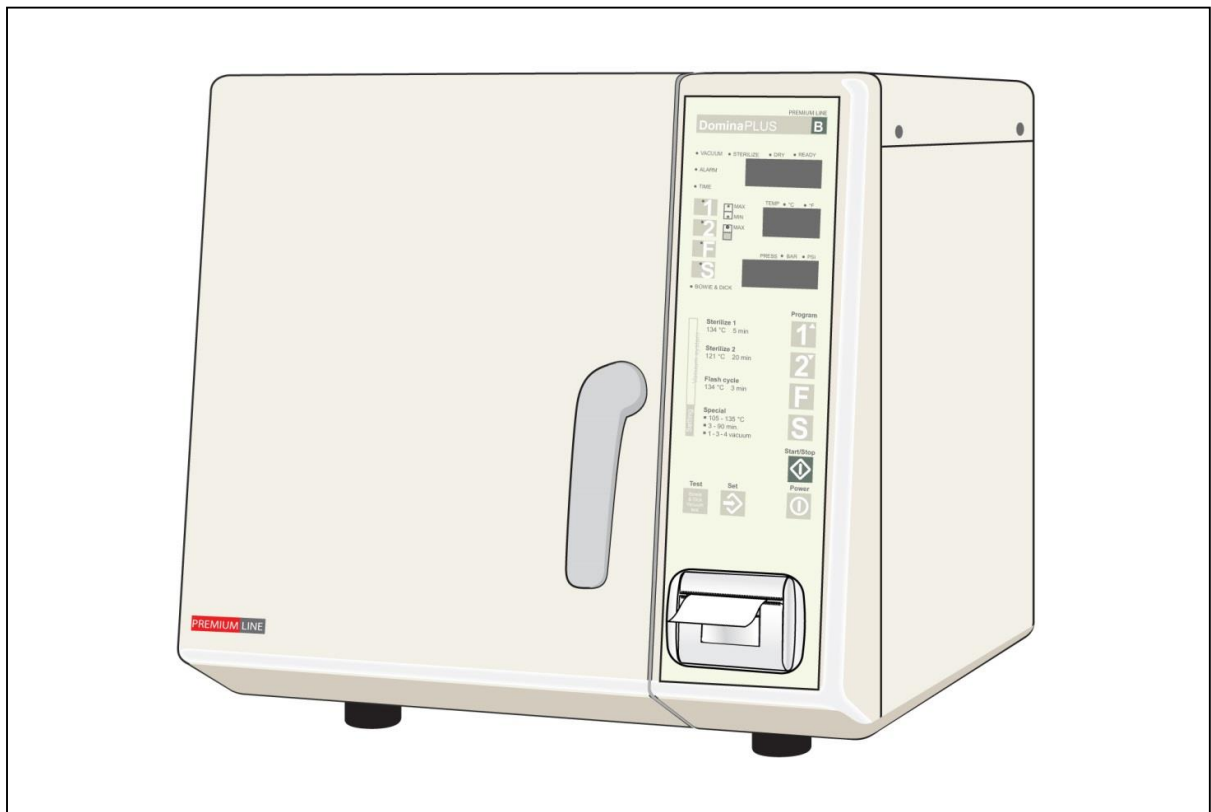

Domina Plus B fulfills all the directions in force concerning the safety, and the built-in parameters has been properly set by the manufacturer in order to warranty effective sterilization if proper loading conditions are followed.

Please, read carefully this manual before using the machine; an improper utilization of the sterilizer should carry on defective sterilization with unattended consequences.

In case of doubt or questions, please call the agent.

Thanks for the confidence given.

All rights reserved

No portion of this publication can be printed, transmitted, rewritten, stored in a data recovery system, translated in any foreign or computer language, in any form or through any devices, without written consent by **DentalX**.

Information in this manual is subject to change without any warning or prior notice by Dental X and does not represent a commitment for the vendor.

Domina Plus B is trademark of *Dental X*.

DENTAL X S.p.A.
Via Marzotto 11
36031 Dueville (VI) Italy
Tel. +39 0444 367400
Fax +39 0444 367436
e-mail: dentalx@dentalx.it
<http://www.dentalx.it>



TABLE OF CONTENTS

1.	GENERAL	2
	1.1 INTRODUCTION	2
	1.2 CONFORMITY TO EUROPEAN DIRECTIVES	2
2.	FAMILIARIZATION	3
	2.1 PACKAGE DIMENSIONS AND WEIGHT	3
	2.2 UNPACKAGING	3
	2.3 OVERALL DIMENSIONS.....	4
	2.4 USABLE SPACE IN THE CHAMBER	4
	2.5 SAFETY FEATURES.....	5
	2.6 PRECAUTIONS AND INTENDED USE.....	6
	2.7 FRONT AND REAR VIEW	8
	2.8 STANDARD ACCESSORIES	9
	2.9 ENVIRONMENTAL CONDITIONS FOR OPERATION AND STORAGE	9
	2.10 TECHNICAL SPECIFICATIONS.....	10
3.	INSTALLATION	11
	3.1 BASIC REQUIREMENTS	11
	3.2 GETTING STARTED	12
	3.3 NOTES ON ALTITUDE COMPENSATION.....	13
4.	OPERATING INSTRUCTIONS	14
	4.1 FRONT PANEL COMMAND/SIGNALING	14
	4.2 RUNNING A STERILIZATION CYCLE	15
	4.2.1 The available sterilization cycle.....	15
	4.2.2 Starting a sterilization cycle.....	16
	4.3 STOPPING THE CYCLE	17
	4.4 TOPPING UP AND DRAINING THE TANKS.....	18
	4.4.1 Topping up the main tank.....	18
	4.4.2 Draining the used water tank	18
5.	PROGRAMMING	19
	5.1 DATE AND TIME	19
	5.2 MEASUREMENT UNIT AND OPTIONS	19
	5.3 SPECIAL CYCLE S5	20
6.	MAINTENANCE	21
	6.1 USER MAINTENANCE.....	21
	6.2 AUTOMATIC PERIODIC CLEANING CYCLE	21
	6.3 CLEANING THE INSTRUMENTS BEFORE THE STERILIZATION	21
	6.4 CLEANING/REPLACING THE WATER INLET FILTER	22
	6.5 REGULAR STERILITY TESTS.....	22
	6.5.1 Bowie & Dick test.....	22
	6.5.2 Vacuum Test.....	22
7.	TROUBLESHOOTING	23
	7.1 MANUAL DIAGNOSIS	23
	7.2 INITIAL AUTO-TEST	24
	7.2.1 Water quality check.....	24
8.	ALARMS	25
	8.1 GENERAL.....	25
	8.2 WARNING MESSAGES	25
	8.3 PRE-WARNING ALARMS	26
	8.4 ABORTED CYCLE ALARMS.....	26
	8.5 CLASS B ADDITIONAL ALARMS	27
9.	CONNECTIONS	28
	9.1 CONNECTION TO AN EXTERNAL PRINTER	28
	9.2 INTEGRATED PRINTER (OPTION).....	28
	9.3 CONNECTION TO A COMPUTER (ONLY FOR SERVICE).....	29
10.	OPERATOR'S NOTES	30
	APPENDIX: SERVICE BOOK	

1. GENERAL

1.1 INTRODUCTION

Object of this manual is to supply instructions for the operators in order to allow:

- correct installation
- right use
- proper maintenance of the sterilizer

The machine must be installed and operated according to the procedures described in this manual.

The user is responsible for what concerns the fulfillment in the legal subject concerning installation and operation of the sterilizer.

If the machine is not correctly installed and operated or the appropriate maintenance is not carried out, the manufacturer cannot be considered responsible for any possible breaks and malfunctions.

Please, check for the packing integrity and no evident damages or missing parts (see delivery note).



IN CASE OF DAMAGES OR MISSING PARTS, PLEASE IMMEDIATELY INFORM AND IN DETAIL THE FORWARDER, DENTAL X AND ITS AREA AGENT.

1.2 CONFORMITY TO EUROPEAN DIRECTIVES

Domina Plus B is produced by *Dental X* and conforms to electromagnetic compatibility standards in accordance with the Medical Devices Directive 93/42/EEC, with European Standard EN 13060 and with the Pressure Equipment Directive (PED) 97/23/CE.

This equipment has been developed and manufactured using high quality material and parts that can be recycled and reused.



This symbol means that electrical and electronic equipment, at the end of their lifetime, must be disposed separately from the household waste. Dispose this unit by carrying it to the local collection/disposal centre. Sanctions are applied in case the regulations concerning waste disposal are not met.

Help us to preserve the environment in which we live!



Mark CE 0051 applied on the rear panel points out the conformity with the Directive 93/42/CEE and warrants the customer that the equipment is safe and according with the international standards .

2. FAMILIARIZATION

2.1 PACKAGE DIMENSIONS AND WEIGHT

Total weight: 55 Kg

Store the package for future shipment.

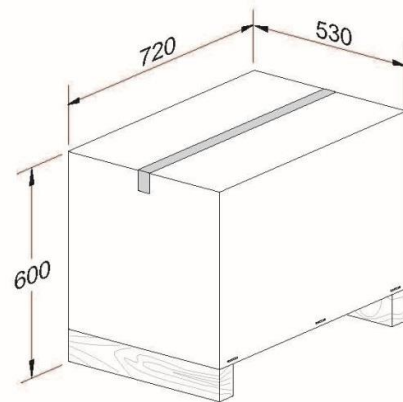

2.2 UNPACKAGING

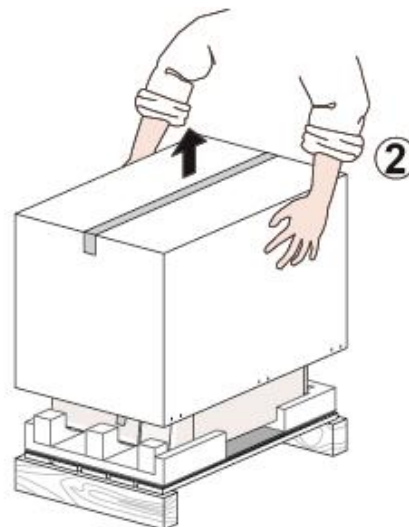
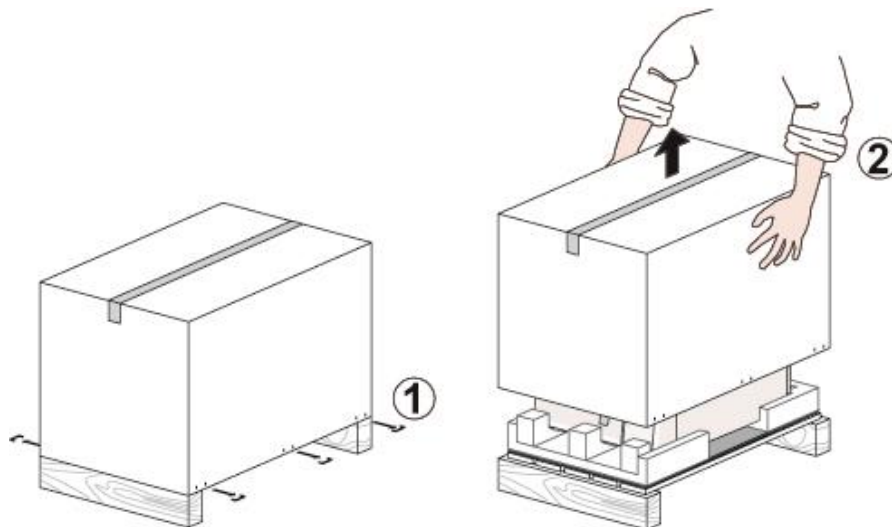

NO!

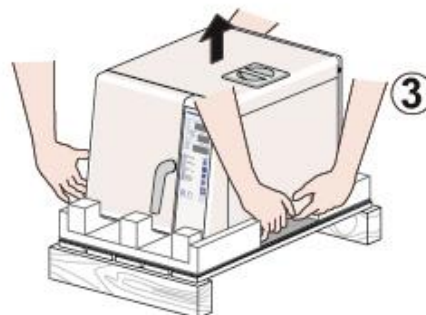
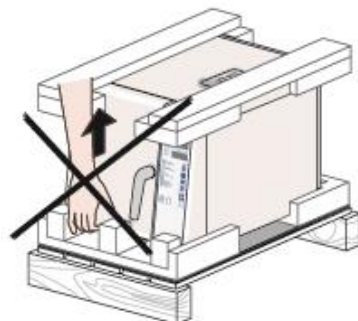

2.3 OVERALL DIMENSIONS

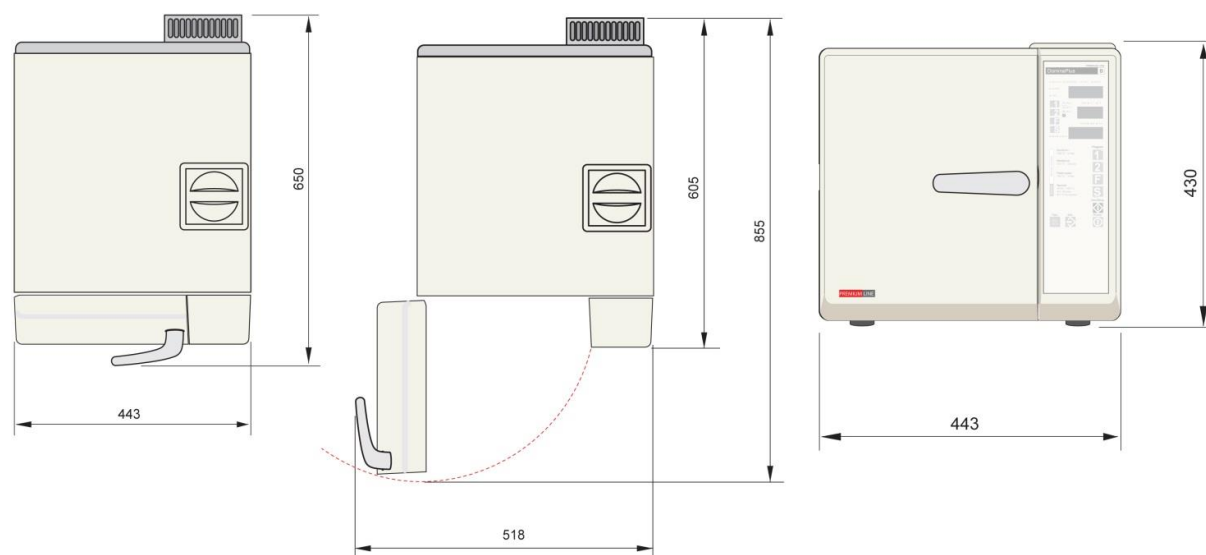

Net weight 45 Kg

Full load weight 57 Kg

2.4 USABLE SPACE IN THE CHAMBER

Diameter: 240 mm

Depth: 384 mm

Capacity: 17,5 liters

Useful dimensions per tray: 315 x 214 mm (x 2),

315 x 168 mm (x 2)

Useful tray volume :

10 liters

2.5 SAFETY FEATURES

The sterilizer features several devices that assure the full safety for of operators.

Door with dual lock control

An electromechanical device allows the door to be opened only if the following conditions are met:

- unit power supplied and turned on
- no current alarms
- internal pressure not dangerous for the operator

For further safety, to unblock the door at the end of cycle or in case of alarm it is necessary to press the Start/Stop button.



Caution: If the equipment is turned off with open door, do not apply force on the handle to try to close the door. To close it, the equipment must be on.

Protection against overpressure – safety valve and decompression valve

- Safety valve - it takes over when the pressure inside the chamber exceeds the value of 2,55 bar. To verify the efficiency of the valve, when the unit is cold and switched off, unscrew the black cap of the valve, when a “click” is heard pull it gently : you have to feel that the cap is free to move. The valve can not be adjusted or serviced for safety reasons. Follow the maintenance program described in the appendix SERVICE BOOK to assure the safety of the unit.
- Decompression valve – it takes over when the pressure inside the camera exceeds the value of 2,4 bar; an acoustic signal warns the operator and the display shows the message ALARM 16.

Overheating protection

The temperature inside the chamber is programmed so as not to exceed the limit of 142 °C; in case of fault, a further protection takes over to prevent the temperature from rising over 150 °C.

Blackout protection

In case of power blackout during the sterilization cycle, the pressure inside the chamber is completely released to the environment value. At the restore of the power supply, the display will show the message BLACK OUT.

Automatic switch off

Elapsed 30 minutes from the end of the cycle without opening the door or without activating a front panel button, the unit will switch off automatically.

This function is not operating if no sterilization cycle has been carried out and completed.

2.6 PRECAUTIONS AND INTENDED USE

The European norms concerning safety and sterilization process defines the following figures:

OPERATOR: the person operating the unit to achieve the expected result.

RESPONSIBLE AUTHORITY: person or group responsible for the use and maintenance of the unit, he or she also has to make sure that.

- all personnel who operate or maintain the equipment are trained in its operation and in its safe use.
- there is regular training of all personnel concerned with the operation and maintenance of the equipment, including emergency procedures for any toxic, flammable, explosive or pathogenic material released into the environment.
- records of attendance at training are maintained, and evidence of understanding demonstrated.

The purpose of this manual is to provide suitable use instructions for both figures: however it does not give instructions concerning the **STERILIZATION PROCEDURE** and the cautions to be followed to prevent contamination of instruments and/or personnel using the unit that is a assignment of the **RESPONSIBLE AUTHORITY** of the practice unit.

We wish to point out the following risks:

- The sterilization is a process that works by means of water steam under pressure and high temperatures; when the load is removed from the sterilization chamber always use tools and wear personal protections suitable for handling hot instruments.
- On opening the sterilizer, especially in case the cycle has been aborted, a small quantity of hot water steam or condensate can be released in the environment; be careful when opening the door.
- If the condensation cycle is not brought to an end, the load, the trays and the tray support as well as the chamber inner space are **ALWAYS** to be considered as potentially contaminating elements, as long as a subsequent sterilization cycle has not been successfully completed.
- The water contained in the recovery tank is to be regarded as biologically contaminating, therefore when this tank is emptied, suitable precautions should be taken. The disposal of recovery water needs to be done in accordance with the national or local regulation. Check the integrity of the draining pipe before its use.
- To prevent cross contaminations during the loading and unloading steps, open the door with clean hands or wear uncontaminated gloves to avoid contaminating the door handle, do not use gloves worn during the instruments decontamination step for this operation; when the sterilized instruments are removed from the chamber, always use uncontaminated gloves.
- In case of contact with hot water, steam or contaminated materials rinse with fresh water and seek for medical help.

The water steam sterilizer is designed to be used for the sterilization of reusable medical instruments that can be steam sterilized in a range of temperatures between 121°C and 135°C; any attempt of sterilizing instruments that are not fit for undergoing this process can result in hazard for the operator: it can also lead to potentially serious faults and damage the sterilizer's safety mechanisms.

The unit is not to be used to sterilize liquids and flammable materials.

The unit is designed for indoor use only.

Do not use in presence of anesthetic or flammable gas.

To avoid an excessive level of humidity, properly air the room where the unit is installed.

SYMBOLS

Hazard symbols are used on the machine and in this manual to highlight phases or parts that may be dangerous due to high temperatures.

	Caution: the instruments and chamber become very hot
	<p>Take care, danger risk. Risk of contamination. Consult the documentation. (Carefully read this manual; improper use may expose the user to health risks)</p>
	This symbol indicates important additional notes for the use of the device.

INTENDED USE

Domina Plus B is a small table steam generator designed to decontaminate dental and medical products in accordance with ISO EN 13060 requirements. Its intended use is to perform:

- Class B sterilisation
The sterilisation of all wrapped or non-wrapped, solid, type A hollow-load products and porous products as represented by the test loads.
- Class S sterilisation:
The sterilisation of products as specified by the manufacturers of the steriliser, including non-wrapped solid products and at least one of the following:
 - Porous products
 - Small porous items
 - Type A and B hollow load products
 - Single-wrapped products
 - Multiple-layer wrapped products

2.7 FRONT AND REAR VIEW

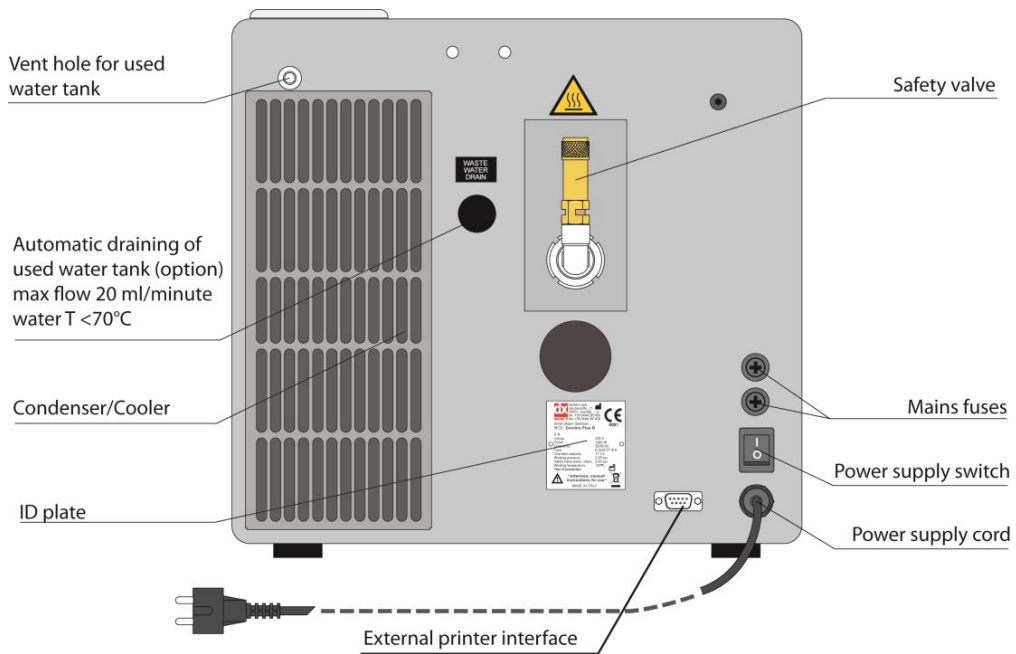
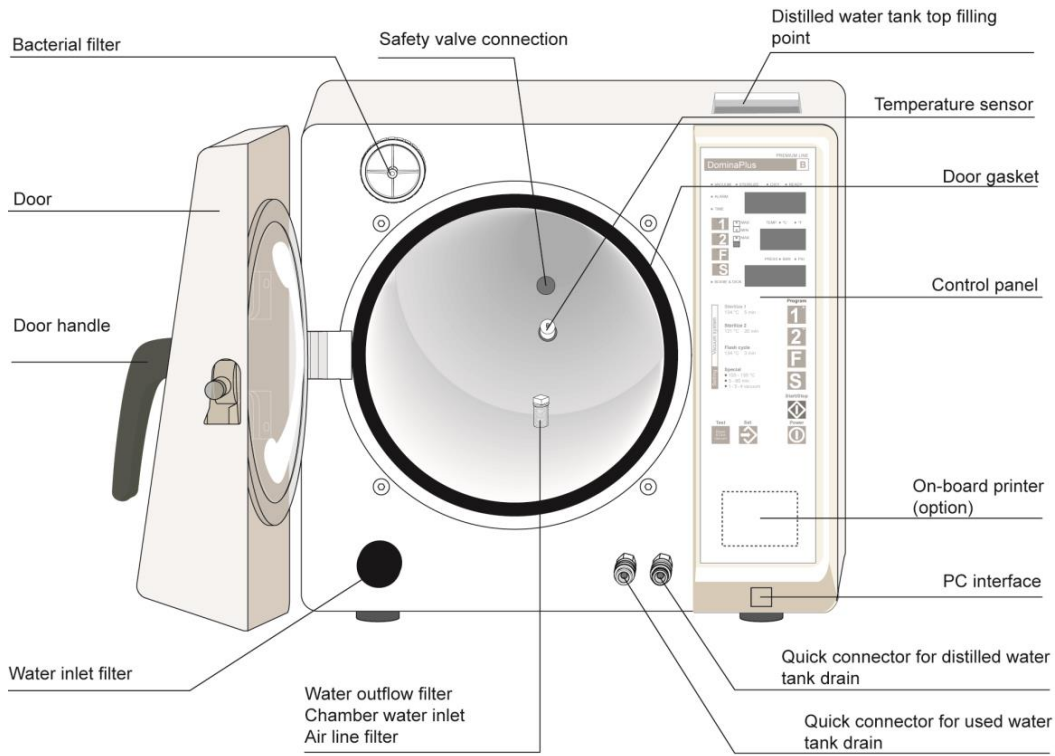

2.8 STANDARD ACCESSORIES

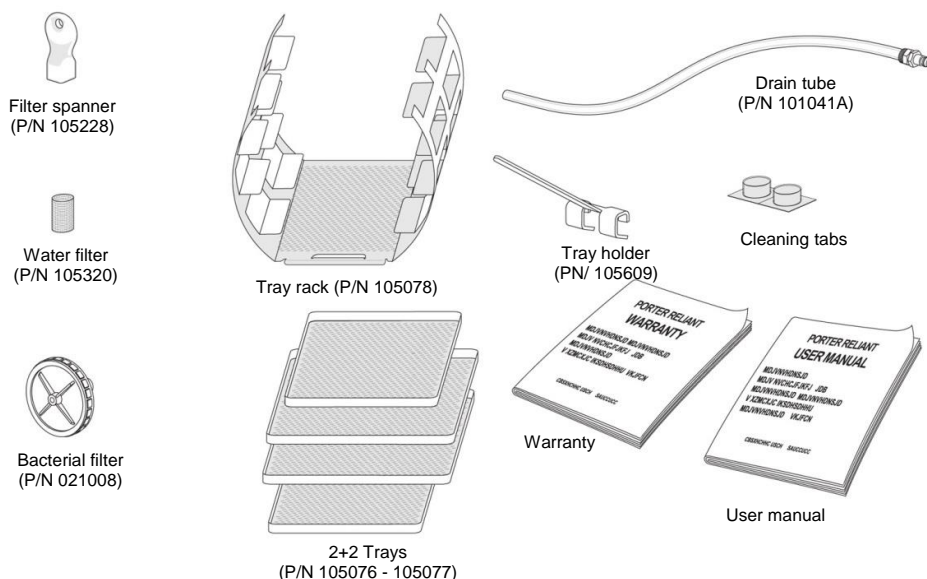

To make the warranty active it is necessary that a copy of the supplied Unit Passport is sent, through the agent, to the manufacturer; for want of this the warranty will decline.

2.9 ENVIRONMENTAL CONDITIONS FOR OPERATION AND STORAGE

The sterilizer is designed to operate in environments with temperatures between 10 °C and 40 °C, relative humidity from 20% to 85%, atmospheric pressure from 750 mBar to 1050 mBar and altitude between 0 and +2000 meters. Storage conditions: temperature -10°C 50°C, humidity without condensation 10-95%, atmospheric pressure 500-1060 mBar.



NEVER USE IN PRESENCE OF INFLAMMABLE ANESTHETIC GAS

2.10 TECHNICAL SPECIFICATIONS

Chamber dimensions	Ø = 240 mm Depth = 384 mm
Chamber capacity	17,5 l
Maximum load	4 kg (solid load) 1,5 kg (porous load)
Warming-up time	20' from room temperature 10' with pre-heated chamber
Sterilization time	from 3' to 90' depending on the selected cycle
Drying time	from 3' to 14' depending on the selected cycle
External dimensions	443 x 590 x 428 mm (L x D x H)
Net weight	45 Kg
Mains voltage	230 Vac
Frequency	50/60 Hz
Max consumption	1920 W
Average consumption	600 W
Standby consumption	12 W (20 W versione printer)
AC fuses	2 x FF 10A (type 6.3 x 32 H 500V)
Clock battery	Internal, not replaceable by the operator: CR2032
Capacity of automatic used-water drain (optional)	Max 0,5 l/min, T max 70 °C
Auto-switching-off	Elapsed 30' from the end of a cycle and without any action
Dual water tank	4 liter each (used and clean water tank)
Vacuum pump	20 l/ min - 0.96 bar
Bacterial filter	0.3 µm at 99.97 %
IP rating (in accordance with EN 60529)	IP31
Differentiated heating system - SDR	
Transmitted heat in environment at 23°C: 0,22 kJ/h	
Sound emission: 52 dB/A at 1 m	
Working cycle: continuous	
Pollution degree: 2	
Transient overvoltage protection: II	
Monitoring of the water conductivity	
Maximum volume available on the trays: 10 l	
Maximum chamber temperature: 135°C (-0/+2°C)	
Safety valve working pressure : 2,55 bar	
Pressurised container conforming to Directive 97/23/EC (PED)	

3. INSTALLATION

3.1 BASIC REQUIREMENTS

1. Check that the mains voltage of your electrical installation matches the value indicated on the equipment plate, the electrical socket is capable to supply at least 10A and is provided with an earth connection. In case the installation makes inaccessible the power supply switch, provides for a proper electrical breaker

The manufacturer will not be responsible for damages to people or things caused by an unsuitable electrical installation or missing of the earth connection.

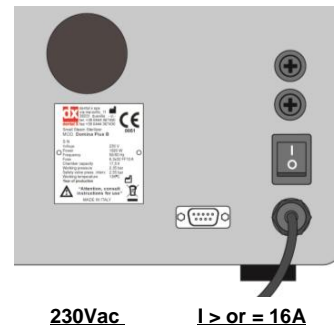

2. The equipment must be installed on a flat surface; adjust the front feet to have a slight slope and so make the outflow of water easier during the drain phase.

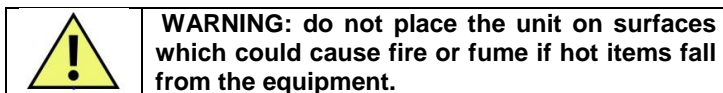

3. For the correct operation, it is mandatory to leave a free space of at least 4 cm on the rear side of the equipment.
4. Do not install the equipment near heat sources, in humid or not well aired environment; in a sterilization room is required a minimum of 10 air changes per hour, a recirculating ventilation system can not be used.
5. On the rear panel it is located the safety valve, if it operates for overpressure it may be released hot steam: locate the unit to eliminate the risk of burning for the operator (ex. near a wall).

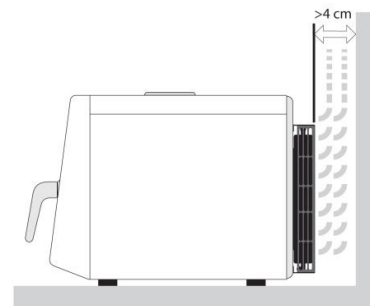

The sterilizer can also be installed in a cabinet. In this case, provide adequate space (>10 cm) for aeration.

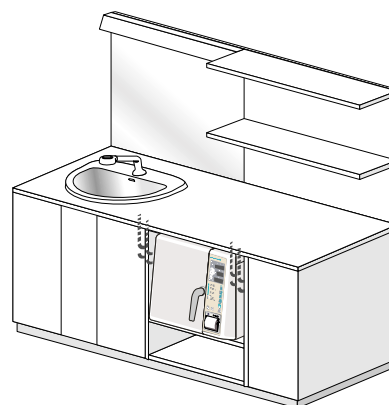

3.2 GETTING STARTED

 **These operations must be carried out only by qualified personnel, wrong settings could affect the quality of the sterilization.**

Check the electrical requirements and connect the power supply cable to the mains socket.

1. The equipment is delivered with empty tank and is therefore necessary to fill it completely with demineralized water. Fill the tank without exceeding the maximum level reference marked on the tank opening.

 The use of low quality demineralized water could create scale deposits on the instruments, inside the chamber and on the trays. Carefully read the label of the demineralized water container. Do not use tap water even if treated with filters or sweeteners.



Do not use water for batteries, other liquids or additives which can cause irreversible damage to the equipment and be a risk for the operator

2. Turn on the equipment with the main switch on the back panel. This switch can be left ON since the electrical consumption in stand-by is almost nil.

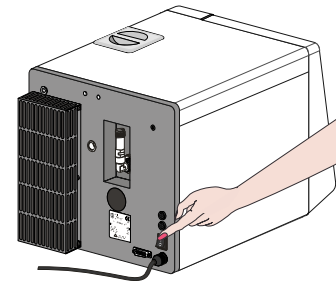

3. Remove the basket and the trays from the chamber and close the door.

 When the unit is off, the door is blocked; if the block persists, turn off and then on again the unit.

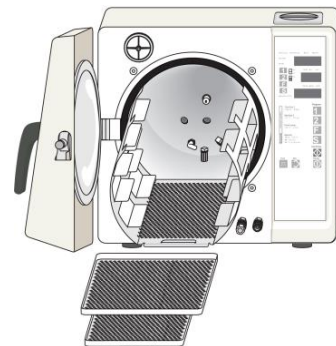

4. Press button **1** and the **Power** button at the same time.; the display shows the message <SET ALT 100 MT> with the set altitude value (100 m).

Use both keys **1** and **2** to adjust the value as necessary according to the actual site altitude (see next page).

Then push the key **Set** to confirm the displayed value and start the automatic initialization procedure with the entry of water in the hydraulic circuit and chamber.

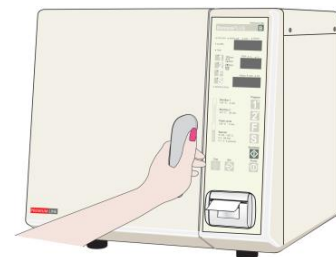

5. At the end of the initialization procedure the Led **READY** turns on; open the door and dry the chamber with a clean cloth.

In case of procedure steps not correctly followed, the display will show one of the following warning messages:

DOOR OPEN: door not closed
ADD H2O: lack of water
NEED INST: initialization procedure not carried out

In this case, repeat the procedure.

 With procedure already been performed, the display will show OFF and the door stays blocked. To unblock it, push the button **Power**.

The sterilizer is ready for use.

Arrange basket and trays in the chamber and select the sterilization cycle.

See Chapter 4 «**OPERATING INSTRUCTIONS**».



3.3 NOTES ON ALTITUDE COMPENSATION

For a proper operation of the pressure control devices, an altitude compensation feature has been introduced.

During the installation procedure it is necessary to set the altitude value (referred to sea level) for the site where the unit operates. This procedure must be carried out every time the unit is moved to a site with different altitude from the one previously set.

During the factory test the equipment is set at a default value of 100 meters and can be left unchanged for real altitude values between 0 and 200 meters, since a ± 100 meter error does not affect the equipment operation.

To be sure of the sterilization process, it is important that the altitude tolerance from the current value does not exceed 200 meters; otherwise, the vacuum devices should be additional loaded, and false or premature AL8 or AL5 alarm should be signaled.

CONVERSION NOTE: to obtain meters multiply feet by 0.3048.

 **These operations can be carried out by qualified personnel. Wrong settings can affect the quality of the sterilization.**

4. OPERATING INSTRUCTIONS

4.1 FRONT PANEL COMMAND/SIGNALING

The front panel is equipped with control keys, signaling Led's and displays. A slight push on a key will activate the command.

LCD Displays: visualize (from the top) the value of the parameters **Time** (Led "Time" turned on), **Temperature** (measure unit: °C or °F depending on the setting, related Led turned on) and **Pressure** (measure unit: bar or psi depending on the setting, related Led turned on); the upper display visualize, instead of time, possible alarms occurred during the cycle (Led "Alarm" turned on).

Phase in progress indication: VACUUM – STERILIZE – DRY – READY - turned on or flashing during the phases of the cycle.

Clean water tank level indication: turned on for maximum or minimum level.

Used water tank level indication: turned on for maximum level.

Current program indication: 1 – 2 – F – S – BOWIE & DICK - turned on for the selected program.

Program selection keys :

- 1** **Program 1** - Sterilization at 134°C, 5 min., 3 vacuum pulses: for wrapped and unwrapped solid instruments
- 2** **Program 2** - Sterilization at 121°C, 20min., 3 vacuum pulses: for porous instruments and fabrics
- F** **Program 3** - Fast sterilization at 134°C, 3min., 2 vacuum pulse
- S** **Program 4** – Four preset cycles (S1, S2, S3 and S4) + 1 cycle (P5) programmable by the operator

Key **Start/Stop**: controls the start or the stop of the selected cycle, unlocks the door at the end of the cycle or in case of alarm occurred during the cycle.

Key **Power**: enables the command panel, the auto-test at the switching-on and the pre-heating resistance.

Key **Set**: allows to set: current date/time, measuring unit, report printout language, temperature/process time/ vacuum pulse number for the programmable cycle.

Key **Test**: allows to carry out the Bowie & Dick Test with sterilizer normally turned on, or the Vacuum Test with sterilizer in stand-by and chamber temperature lower than 35°C.



4.2 RUNNING A STERILIZATION CYCLE

- Turn on the equipment by means of the rear switch.
 - Display **TIME** is showing the current time
 - Display **TEMP.** is showing OFF
 - Display **PRESS** is showing the current day and month
- Press the key **Power** and wait for a few seconds the initial auto-test completion; during this time the parameter set-points and the components currently tested will appear in a sequence on the display. Over the auto-test, the display **TIME** will show again the current time, the display **PRESS** the value of the current pressure, the display **TEMP** the value of the current chamber temperature (if lower than 35 °C the display will show the message "low"). The microprocessor enables the pre-heating step in order to rise the chamber temperature up to 100 °C.

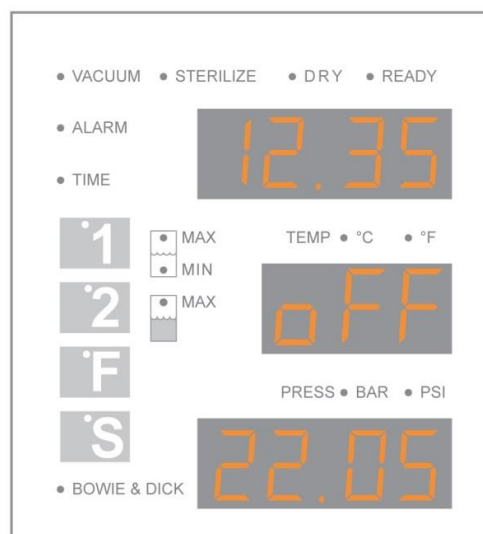

- ☞ During this phase the temperature reading on the display is inaccurate, because no steam being there.
- Arrange the material to be sterilized on the trays, load the chamber and close the door.
 - Check that Led **H2O MIN** (main tank signaling) is off. If not, fill up the tank with demineralized water up to the lighting of Led **H2O MAX**.

4.2.1 The available sterilization cycle

Key	Parameters	Load type (*)	Cycle	Parameters	Max load	Check test
1	134°C, 5' three pre-vacuum pulses, drying 10' (6' with vacuum + 4' with ventilation)	Solid, porous, hollows type A and B, wrapped (ref. EN868)	B	134-137°C 2,04-2,25 bar	4Kg solid or 1,5kg porous or a combination of both in proportion.	Helix test EN13060 Par 10.6
2	121°C, 20' three pre-vacuum pulses, drying 11' (7' with vacuum + 4' ventilation)		B	121-124°C 1,04-1,24bar		Helix test EN13060 Par 10.6
F	134°C, 3' double pre-vacuum pulse drying 5' (3' with vacuum + 2' ventilation)	Solid instruments, unwrapped	S	134-137°C 2,12-2,30 bar	4Kg solid	Solid load, unwrapped EN13060 Par 10.5
S	S1 105°C, 8' (three pre-vacuum pulses, drying 6' + 4')	Solid, porous, hollows type A and B	Disinfection	105-108°C 0,21-0,35 bar	4Kg solid or 1,5kg porous or a combination of both in proportion.	NA not a sterilization cycle
	S2 134°C, 5' (four pre-vacuum pulses, drying 7' + 5')	Solid, porous, hollows type A and B, wrapped (ref. EN868)	B	134-137°C 2,04-2,25 bar		Helix test EN13060 Par 10.6
	S3 121°C, 20' (four pre-vacuum pulses, drying 7' + 5')		B	121-124°C 1,04-1,24bar		Helix test EN13060 Par 10.6
	S4 134°C, 18' (three pre-vacuum pulses, drying 6' + 4')		B	135-138°C 2,12-2,30 bar		Helix test EN13060 Par 10.6
	S5	Parameters to be set and range: Temp.: 105 – 135°C Process Time: 3' – 90' Pre-vacuum pulses: 2, 3 or 4 Drying (vacuum + ventilation): 3'+2', 6'+4', 8'+6'	Depends on the parameters set	Depends on parameters set		105-138°C 0,21-2,30 bar
Test B&D	134°C, 3,5' three pre-vacuum pulses drying 10' (6' with vacuum + 4' ventilation)	Test B&D (3M™ COMPLY™ cod. 1300)	TEST	134-137°C 2,04-2,25 bar	B&D test pack or equivalent	NA Not a sterilization cycle
Vacuum test	Temperature under 35°C		TEST	< 35°C	Empty chamber	NA Not a sterilization cycle

(*) Liquids excluded

To select the programs **1** , **2** or **F** press the relating key.

To select one of the option **S** programs, hold down the key **S** and press the key **1** or **2** to visualize and select on the lower LCD display the choice available (S1, S2, S3, S4 or S5).

The indication Led of the selected program turns on, and the displays will show for 5 seconds the parameters of the cycle currently selected.

4.2.2 Starting a sterilization cycle

Press the key **START/STOP** to start the selected cycle.

 The programs F, S1 and S5 do not warrant the Class B sterilization; to start these types of cycle, hold down the key **F** (or **S**) and push the key **Start/Stop**.

The door is locked and stays locked throughout the cycle duration.

The parameters of the selected cycle are shown once again for 10 seconds, then the sterilizer starts and runs the cycle phases automatically. The various steps of the cycle are microprocessor controlled and sequentially shown on the display; in this way the operator can monitor the progress of the sterilization phases and times.

The signaling for the various phases of the cycle are reported below:

- Led VACUUM turned on
- Display TIME starts to record the cycle duration
- Display PRESS shows the chamber pressure value
- Display TEMP. shows the chamber temperature value
- The program indication Led (1, 2, 3 or 4) starts to flash.

Vacuum phase (water entry in the chamber and pre-vacuum pulses)

During this phase the microprocessor enables the vacuum pump and enters a water dose in the chamber. Led **VACUUM** is flashing. This phase will be repeated more times and should require 10 to 20 minutes depending on the chamber conditions and load type to be processed. Pump operation may be slightly noisy.

 For unwrapped solid instruments we recommend to use the cycle F. In this way the sterilization time will be faster, and power consumption reduced.

Sterilize phase

Reached the preset parameter values, Led **VACUUM** turns off and Led **STERILIZE** turns on. The display Time starts the countdown marking the time remaining to the end of the sterilization process, the Pressure and Temperature displays show respectively the P and T values of the steam.

The sterilization phase is followed by the decompression phase, with the display Pressure showing the decreasing pressure values down to 0. Again, the display Time will start the countdown of the decompression phase. Based on the our experiences, the decompression time has been slightly extended in order to minimize the thermal shock consequent to the status change of the steam.

Drying phase

Over the decompression phase, Led **STERILIZE** starts to flash to signal the completion of the sterilization process. At the same time the Led **DRY** turns on, signaling the start of the drying phase. Throughout this phase, the chamber heaters keep the chamber warm according to a microprocessor-controlled logic, the vacuum pump comes again into operation to eliminate the residual steam. The display Time shows the countdown of this phase. Follows the forced ventilation phase through the bacterial filter – the display Time shows also the countdown of this phase.

End of cycle

As soon as the drying is over, Led **DRY** turns off, and Led **READY** and **STERILIZE** turn on. A 10-second alert signal is generated to draw the operator attention. The chamber heaters are set at reduced power (pre-heating) until the door is open. The display Time shows the total time of the cycle, the Pressure and Temperature displays show respectively the current P and T of the chamber.

 At the end of cycle F, S1 or S5 only the Led **READY** will light and not **STERILIZE** to signal that the cycle selected by the operator does not warrant a Class B sterilization; the display will show the cycle counter.

To unlock the door before opening it, press the key **Start/Stop**.

The cycle is over and the load can be taken out.



Opening the door, the displays will show again the current time, chamber temperature and pressure, and the sterilizer is ready for a new cycle.

In case of on-board printer or external printer connected, a report will be issued during the cycle phases with the more significant data; the report can be filed as proof of the sterilization process performed.

The operator can arrange other load on the trays and start a new sterilization cycle. with the advantage of shorter heating-up time as the chamber is already warm, or press key **Power** to put the unit in stand-by status (*OFF on the display*).

 If the door is not opened or a key pressed within 30 minutes, the unit switches to stand-by status (OFF) automatically.

Should any failure or error occur during the cycle, Led **ALARM** turns on, the display Time will show the type of alarm (see chapter ALARM) and the door remains locked. To unlock the door, press key **Start/Stop**.

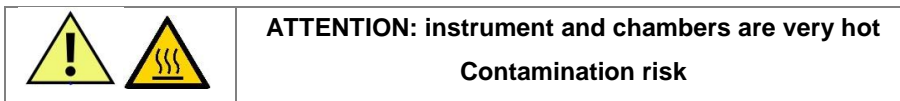

4.3 STOPPING THE CYCLE

To stop the sterilization cycle, press key **Start/Stop**. The display Time shows the message "**MANU STOP**".

Before opening the door, make sure that the display Pressure is showing the value 0. A safety device will anyway prevent from opening the door if the chamber is over-pressurized.. To unlock the door, press key **Start/Stop**.

Remove the load and check for the presence of water into the chamber. In case of wrapped instruments, we suggest to replace with new bags.

Before loading the chamber again, dry it carefully and wait 10 minutes to allow the water to evaporate and be drained completely.

4.4 TOPPING UP AND DRAINING THE TANKS

The sterilizer is fitted with two 4-liters tanks: main tank for the clean demineralized water and recovery tank for the used water.

The hydraulic system does not reuse the condensate obtained during the sterilization process; this condensate is collected in the recovery tank which must be periodically drained. This mode of operation involves the progressive main tank emptying and recovery tank filling.

4.4.1 Topping up the main tank

The average water consumption per sterilization cycle is 520 cc, hence 7 cycles can be performed with a full tank .

The of the Led **H2O MIN** signals a water level into the main tank insufficient to perform a new cycle.

Provides for the topping up of the main tank, taking care to not exceed the grid on the entrance. The lighting of the Led **H2O MAX** and a acoustic warning signals that the tank is full.



CAUTION: take care not to touch hot parts when removing the cap from the main tank.

4.4.2 Draining the used water tank

The lighting of the Led **H2O MAX** relative to the used water tank warns that the maximum level has been reached. In this case :

- Get a bucket or a tank of at least 4 l capacity,
- Fix the supply drain tube into the left fast fitting (gray),
- Wait for a complete draining,
- Unfit the tube pushing the ring nut against the machine and drawing the tube.



CAUTION! The water contained in the used water tank is to be regarded as biologically contaminating, therefore when this tank is emptied, suitable precautions should be taken. The disposal of recovery water needs to be done in accordance with the national or local regulation.

5. PROGRAMMING

5.1 DATE AND TIME

Push the key **Set** and use the keys **1** and **2** to adjust the value. Whenever key **Set** is pushed, a different time parameter can be controlled:

PRESS IN A SEQUENCE	DISPLAY TIME	PARAMETER TO BE SET	USE KEY 1 to increase the value, or 2 to decrease the value
SET	SET YEAR	YEAR	
SET	SET MONTH	MONTH	
SET	SET DAY	DAY	
SET	SET HOUR	HOUR	
SET	SET MIN	MINUTES	
SET	Exit the programming mode		

Example: for hour adjustment, push key **Set** four times and set the time by the keys **1** and **2**

5.2 MEASUREMENT UNIT AND OPTIONS

<p>Push in a sequence the keys Set and F to access the programming mode</p>	<p>Display PRESS is showing: <i>SET UNIT °C</i> or <i>SET UNIT F</i></p> <p>Display TIME is showing: <i>L1</i> <i>L2</i> <i>L3</i> <i>L4</i> <i>L5</i></p>	<p>Push the key 1 to set the desired temperature measurement unit</p> <p>Push more times the key 2:</p> <p>L1 = Italian L2 = English L3 = German L4 = French L5 = Spanish</p> <p>} to set the language of the print report</p>
<p>Press key Set</p>	<p>Display PRESS is showing: <i>SET UNIT BAR</i> or <i>SET UNIT PSI</i></p>	<p>Push the key 1 to set the desired pressure measurement unit</p>

Push again the key **Set** to exit the programming mode

The equipment is normally preset in the factory with “°C” and “bar” measurement units; the default language is English (L2).

5.3 SPECIAL CYCLE S5

The operator can set a customized sterilization cycle as follows:

Push the keys Set and S in a sequence	Display PRESS is showing: <i>SET TEMP</i>	Set the process temperature value between 105 and 135 °C by the keys 1 and 2
Push again the key Set	Display PRESS is showing: <i>SET TIME</i>	Set the process time between 3 and 90 minutes by the keys 1 and 2
Push again the key Set	Display PRESS is showing: <i>VAC</i> or <i>DRY</i>	Set the number of vacuum pulses (2, 3 or 4) by key 1 ; the value is shown close to the message <i>VAC</i> . Set the duration of the drying phase (vacuum + ventilation = 3+2, 6+4 or 8+6 minutes) by the key 2 ; the value is shown close to the message <i>DRY</i> .

Push again the key **Set** to exit the programming mode.

The parameter values for the special cycle S5 are automatically stored and maintained until new values are set through the same procedure.



The combination of time/temperature parameters set by the operator can lead to cycles that do not assure the sterilization. It is necessary to check the effectiveness of the customized cycle by means of suitable tests.

At the end of the special cycle S5, only the Led *READY* will switch on - not *STERILIZE* - to signal that the efficiency of the cycle selected by the operator has not been validated by the manufacturer.

6. MAINTENANCE

6.1 USER MAINTENANCE

Manual cleaning of the chamber with a damp cloth	daily
Cleaning the air filter (P/N 105320)	weekly
Cleaning the clean water tank	Every 60 cycles (when the display indicates "NEED CLEANING")
Replacement of the bacterial filter (P/N 021008)	6 months / 500 cycles
Cleaning the chamber with the automatic cleaning cycle (Ref. 6.2)	Every 60 cycles (when the display indicates "NEED CLEANING") and/or after a long period without use.

6.2 AUTOMATIC PERIODIC CLEANING CYCLE

For a proper operation of your sterilizer it is indispensable that a correct and regular maintenance is carried out. To this end, it is important to perform a cleaning procedure, as described on the following, at least once every 15 days or, in case of intense usage, every two water full of the main tank.

 For further safety, after 60 cycles carried out without an intermediate cleaning cycle, the equipment will display the message <NEED CLEANING >.

IMPORTANT Take the basket and the trays out of the chamber and wash them with an ordinary dish washing powder, rinse with water and wipe.

DO NOT USE ABRASIVE PRODUCTS.

WARNING DO NOT PERFORM THE CLEANING CYCLE WITH TRAYS IN THE CHAMBER.

Carry out the chamber surface cleaning when the equipment is cold.

NOTE To open the door and carry out these preliminary operations, it is necessary to switch on the equipment; ended the maintenance, switch off the unit to avoid excessive heating. To close the door switch on the unit again.

- Put a cleaning tab in the chamber and close the door **THE CHAMBER MUST BE EMPTY !**
- Set the equipment in stand-by mode by pushing the key **Power** (**OFF** on the display).
- Hold down the key **Start** and push the key **Power** to start the automatic cleaning cycle; this cycle takes approx. 15 minutes.
- At the end of the cycle, the Led **READY** will turn on; open the door and wipe the chamber with a clean cloth slightly soaked with demineralized water and pure alcohol. **Do not use sponges, brushes, abrasive steel wool or paper.**



Thank to the electronic control system, the number of maintenance cycles actually performed is continuously recorded and updated.

The missing of appropriate and regular maintenance according to the above guidelines could cause an early and more frequent service activities and the **lapse of the warranty.**

6.3 CLEANING THE INSTRUMENTS BEFORE THE STERILIZATION

In order to extend the sterilizer life, we recommend to carry out an accurate cleaning of instruments; one of the main causes of an early equipment wear is the settlement and accumulation of debris and fragments for inadequately instrument cleaning, and consequent stains, fouling and progressive clogging of filters, electro-valves and tubing.

6.4 CLEANING/REPLACING THE WATER INLET FILTER

To carry out the clean or the replacement of the filter on the left of the front panel, proceed as follows:

1. Drain completely the main tank by plugging the supply tube (un-threaded end) into the right fast fitting (white) of the front panel.
2. Remove the black cap (1) from the filter housing, be careful of possible outflow of water from the internal hoses. The filter is fitted to the cap.
3. Clean the filter (3) with compressed air (or an ultrasonic cleaner) or replace it if damaged.
4. Refit the cap, taking care to ensure that it is fully inserted.
5. Fill the main tank with demineralized water as for the standard operation.
6. Switch on and put the equipment in stand-by mode (**OFF** on the display), hold down the key **2** and push the key **Power**.



The equipment starts an automatic initialization procedure, with the exhausting of the residual air out the filter. The end of the procedure is signaled by the lighting of the Led **READY**.

6.5 REGULAR STERILITY TESTS

During the factory tests and according to the standing regulations, the sterilizers are deeply tested and the calibrations checked; these tests warrant the sterilizer performances except for unauthorized interventions, tampering or an improper usage. Although the unit is equipped with an advanced diagnosis and process evaluation system, is user responsibility of checking periodically the performance in the course of the equipment life. The frequency of these checks is regulated at local country level; check the regulations in force.

For any explanations or information, contact your authorized reseller or directly Dental X.

6.5.1 Bowie & Dick test

The test can be performed at any time with the sterilizer turned on and operating.

- Load the sterilization chamber with a B&D test (i.e. 3M™ COMPLY™ cod. 1300) according to the standards for the test procedure.
- Hold down the key **Test** and push the key **Start/Stop**.

The test cycle starts with cycle phases characterized by 3 pre-vacuum pulses, process temperature of 134°C and process time of 3,5 min.

 Simulators of the B&D test are available on the shelf, developed for big sterilizers and equivalent to a texture load of 7Kg; it is clear that the chamber dimensions do not allow such a load, but a positive result of this test is indication of efficient sterilizer features.

6.5.2 Vacuum Test

 We suggest to carry out the test at the beginning of the working day in order to check the chamber and system tightness.

The test should be started with equipment in stand-by mode (**OFF** on the display) and chamber temperature lower than 35°C (normal conditions at the beginning of the working day).

- Push the key **Test**
- The vacuum test starts automatically and takes about 15 minutes.

In case of negative result, the display Alarm/Time will show **TEST FAIL** to warn for insufficient tightness of the chamber (see Chapter 8 - Alarms).

7. TROUBLESHOOTING

7.1 MANUAL DIAGNOSIS

The operator or technician can perform at whenever time a test to check the correct operation of the equipment; proceed as follows:

Step 1

Action	Message/Signaling on the display
Push the keys Set and Test in a sequence	The displays show respectively (from the one at the top): message "TEST", chamber temperature value and pressure value.
Push the key 1	Temperature value of the chamber's top wall
Push the key 2	Temperature value of the chamber's bottom wall
Push the key F	Message "CICL" and number of the performed cycles
Push the key S	Message "ABOR" and number of the aborted cycles
Push the key Test	Number of the automatic cleaning cycles actually performed
Push the key Power	Message "ALARM" and codes of the last three alarms occurred
Push the key Set	Exit the diagnosis and return to the normal mode

 During the manual diagnosis, it is impossible to set the unit in stand-by mode with the key **POWER**. First you need exit the diagnosis mode by pushing the key **Set**.

The use of these procedures is reserved for qualified personnel.

Step 2

Action	Message on the display / Result
Push the keys Set and Power in a sequence	Message "TEST OUT"
Push the key 1	Electro-valve 1 energized (open)
Push the key 2	Electro-valve 2 energized (closed)
Push the key F	Electro-valve 3 energized (open), electro-valve 5 energized (closed), vacuum and water pumps energized
Push the key S	Electro-valve 4 energized (open)
Push the key Power	Electro-valve 5 energized (closed)
Push the key Test	Condenser's fan powered
Push the key Set	Exit the diagnosis and return to the normal mode

7.2 INITIAL AUTO-TEST

Each time the equipment is switched on, starts an automatic test (duration approx. 15 s) checking sequentially any main component.

Three beeps signal the end of the auto-test and, if positively passed, the message **Card Good** is displayed .

Whatever fault detected, it will be shown on the display and stored with the alarm code of the Table C (see chapter ALARM).

To skip the auto-test, turn on the unit holding down any key.

7.2.1 Water quality check

To prevent the accidental use of poor quality demineralized water, the sterilizer is equipped with a device that monitors the water conductivity; this check starts at the switching-on (initial auto-test), provided that the unit is at environment temperature and with the main tank full.

At the end of the auto-test, the display will show the message « **H2O good** » or « **H2O hard** » if the measured conductivity value is respectively lower or higher than 15 μ S.

ATTENTION

The negative result of the water quality check does not stop the operation of the sterilizer; anyway, it is strictly recommended to replace the water with a type of better quality.

The following table shows the minimum values suggested for the feeding water.

Polluting agents	Feeding water	Condensate
evaporation residue	≤ 10 mg/l	$\leq 1,0$ mg/l
silicon oxide	≤ 1 mg/l	$\leq 0,1$ mg/l
iron	$\leq 0,2$ mg/l	$\leq 0,1$ mg/l
cadmium	$\leq 0,005$ mg/l	$\leq 0,005$ mg/l
lead	$\leq 0,05$ mg/l	$\leq 0,05$ mg/l
heavy metal residues, included iron, cadmium and lead	$\leq 0,1$ mg/l	$\leq 0,1$ mg/l
chlorine	≤ 2 mg/l	$\leq 0,1$ mg/l
phosphate	$\leq 0,5$ mg/l	$\leq 0,1$ mg/l
Conductivity (at 20°C)	≤ 15 uS	≤ 3 uS
Ph	from 5 to 7,5	from 5 to 7
appearance	colorless, clean, without sediment	colorless, clean, without sediment
hardness	$\leq 0,02$ mmol/l	$\leq 0,02$ mmol/l

8. ALARMS

8.1 GENERAL

At equipment turned on and during every cycle, the internal supervising system constantly monitors the parameters characterizing the sterilization phases, the proper operation and the status of the main components. Any detected anomaly or fault is promptly signaled through specified messages, coded alarms and acoustic signaling.

To easy the interpretation and identification, the alarms have been divided into four classes, as shown in tables A, B, C and D.

8.2 WARNING MESSAGES

Table A reports the warning messages displayed.

TABLE A

Message	Cause	Solution
OPEN DOOR	Door not opened at the end of the cycle. Start command entered with the door open.	Open the door. Close the door
FAIL	Failed cycle	See table C
DRY FAIL	Drying phase not completed due to manual interference (the load has been removed before the drying cycle completion). However the sterilization process has been achieved.	Push the key STOP .
ADD H2O	Insufficient water in the main tank (the message appears before starting a cycle)	Top up the main tank.
FULL H2O	The used water tank is full (the message appears before starting a cycle)	Drain the used water tank
MANU STOP	Cycle manually interrupted. Sterilization process not completed	Wipe the chamber (if wet) and start again the cycle
BLAC OUT	Black-out occurred during the cycle	Check the AC plug and socket. Wipe the chamber and repeat the cycle.
NEED CLEANING	60 cycles carried out from the last automatic cleaning cycle	Perform the automatic cleaning cycle (see Chapter 6.1)
NEED SERVICE	One year from the installation or over 1500 cycles performed without any service check-up	The warning message disappears as soon as a cycle is selected, but will appear again at the next switching on. Call for a complete check-up by a qualified technical service; the message will be reset after the servicing.
NEED INST	Need for the installation procedure.	Perform the installation procedure (see Chapter 3.2)
NEED TEST	Detected a pre-warning alarm	See table B
TEST FAIL	Negative result of the Vacuum Test	Clean the door gasket and repeat the test. Call for a technical service

8.3 PRE-WARNING ALARMS

The alarms shown on table B do not stop the operation of the sterilizer, but warn that a problem might interfere with the correct working of the sterilizer.

Check the trouble and promptly carry out the recommended action.

In case of fault, the message **Need Test** will appear along with the code number of the detected alarm.

Example: Need Test cd 1.

TABLE B

Alarm code	Cause	Solution
cd 1	Drain filter dirty	Clean or replace the filter
cd 2	Slow heating of the top wall of the chamber	Perform a cycle with reduced load. In case, call for a technical service. Check the mains voltage.
cd 3	Slow heating of the bottom wall of the chamber	Perform a cycle with reduced load. In case, call for a technical service. Check the mains voltage.
cd 4	Water dose distributor clogged Water inlet filter dirty	Impurities in the main tank . Carry out the filter maintenance (see § 6.3). Carry out the automatic cleaning cycle (see 6.1)
cd 5	Water entry valve dirty	If the problem occurs more than 3 times, call for a technical service
cd 6	Bacterial filter clogged	Replace the filter
cd 7	Vacuum phase too slow	Wipe the chamber and perform the automatic cleaning cycle (see § 6.1).

8.4 ABORTED CYCLE ALARMS

The alarms shown on table C refer to faults keep the sterilization process from being completed.

Identify the fault on the table and carry out the recommended action.

The alarm condition is signaled by the Led **ALARM**, and the Alarm/Time display will show the message **FAIL** (intermittent) along with the code number of the detected alarm. Example: **FAIL AL 6**.

TABLE C

Alarm code	Cause	Solution
AL 1	Electro-valve 1 faulty	Call for a technical service
AL 2	Electro-valve 2 faulty	Call for a technical service
AL 3	Electro-valve 3 faulty	Call for a technical service
AL 4	Electro-valve 4 faulty	Call for a technical service
AL 5	The pressure has not reached the set-point value within the preset time	Overload or pressure weak. Perform the automatic cleaning cycle (§ 6.1)
AL 6	Too long time of the initial vacuum phase	Perform the automatic cleaning cycle (§ 6.1)
AL 7	Door not properly locked	Make sure that the door is correctly closed.
AL 8	Air into the sterilization chamber	Check the door tightness. Clean the gasket.
AL 9	Stop of the countdown for over 60 sec. during the sterilization phase	Check the door tightness. Perform, if needed, the automatic cleaning cycle (see § 6.1), and the Vacuum Test.
AL 10	Pressure too high	Call for a technical service.
AL 11	Pressure too low	Check the door tightness. Perform, if needed, the automatic cleaning cycle (see § 6.1).

Alarm code	Cause	Solution
		Perform the vacuum test
AL 12	Temperature out the normal range	Perform the automatic cleaning cycle (§ 6.1).
AL 13	Chamber's temperature sensor faulty	Call for a technical service
AL 14	Chamber's top wall temperature sensor faulty	Call for a technical service
AL 15	Chamber's bottom wall temperature sensor faulty	Call for a technical service
AL 16	Pressure sensor faulty	Call for a technical service

8.5 CLASS B ADDITIONAL ALARMS

TABLE D

Alarm code	Phase involved	Cause	Solution
AL 18	Drying phase	Drying interrupted	Dry the load
AL 31	Drying phase	Vacuum not sufficient	Excess of load

NOTE: *The Class B alarms may occur only for the programs 1, 2, S2, S3 and S4.*

9. CONNECTIONS

9.1 CONNECTION TO AN EXTERNAL PRINTER

The equipment not supplied with an internal printer, is provided with serial interface for the connection to an external printer the process data are sent to, in order to document and certify the sterilization process performed. The use of a printer, mandatory in some countries, will become more and more frequent with the growing need to document the effective sterilization of the instruments, also for its forensic and medical aspects.

 The printer cable cannot exceed 3 meters.

The serial port of the equipment can be connected to a printer with serial interface RS232. Please contact *Dental X* for further information.

1. Switch-on the printer,
2. Switch-on the sterilizer.

The report is automatically printed on the course of the cycle and with the following data content:

date and time of the process – progressive cycle number - selected program and parameters - cycle type: sterilization or disinfecting – start/end time of the sterilization phase - end time of the drying phase

In case of trouble or cycle interruption, the printout will report the message **ABORTED CYCLE - NOT STERILE** along with the indication of the detected alarm.

Remember to switch off the printer at the end of the working day.

 To set the language for the report printout see the chapter 5.
The PRINTER port interfaces only a printer directly.

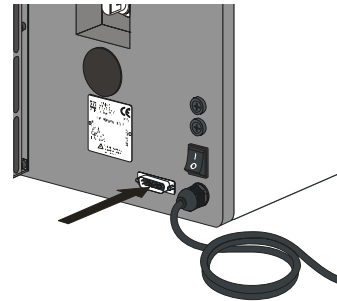

9.2 INTEGRATED PRINTER (OPTION)

The model with a thermal printer does not require an additional installation for the report printing. The printer's Led **POWER** indicates the correct power supply, while the Led **ERROR** indicates a lack of paper.

Replacing the paper roll

- Open the door by leveraging on the tab at the top.
- Remove the empty roll and plug in the new, taking care to put upwards the sensitive side of the paper (see figure).
- Close the door, leaving about 5 cm of the outside
- Use original chemical paper, 57 mm wide and 30 mm diameter.

The report is printed automatically on the course of the cycle as for the external printer. If report printout is not required, leave open the printer door before starting the cycle.

NOTES:

1. *In the model with integrated printer, the serial interface connector is not installed.*
2. *If one or more parameters exceed the set-point values, the sterilizer enters automatically in alarm status and the relative indication will be reported on the printout.*
3. *If the cycle appears as correctly completed, there is no need to check on the report that any parameter value is within the limits.*



Example of alarmed report

```

_____ CLASS B _____
DOMINA PLUS
Serial No 001091
Date 14.02.11
Prog. 1
134 C 5'
Cycle 001343

START
Time 13:45:34

ABORTED
Time 13:45:35
ALARM N. 7
  
```

9.3 CONNECTION TO A COMPUTER (ONLY FOR SERVICE)

The steriliser is completely controlled by a microprocessor and can be connected to a device that saves the sterilisation reports on a USB flash drive instead of printing them on paper.

For connection and use, refer to the user manual for the device.

The socket is also used for the diagnostics and technical support system through a dedicated interface provided to authorised service centres.

The socket is protected by a cap to prevent the insertion of foreign objects, which could damage the device. Do not remove it if the device is not in use.

Do not connect devices not supported by the manufacturer.



THE RJ45 CONNECTOR IS NOT DESIGNED FOR A LAN CONNECTION, THIS OPERATION WILL DESTROY THE MOST OF THE ELECTRONIC PART OF THE AUTO-CLAVE.

Although the sterilizer's average life is about 10 years, it is compulsory to carry out periodic controls in order to check the correct calibration and for possible wear of components. The control interval, as reported on the Service Book, is 1 year or 1500 cycles for the ordinary maintenance, and 4 years or 10.000 cycles for the special maintenance. The sterilizer is configured to signal on the display, as the first term comes to expire, the message "NEED SERVICE". This feature is in compliance with the norm EN13060 and answers to specific safety requirements. The maintenance activities must be performed by authorized technicians (provided with card or certificate released by *Dental X*) and reported on this Service Book.

Model Serial Number

Installation Date Altitude

Installer

Reseller

Sterilization Manager:

Standard periodic checks

Pos.	Check/Activity	Ordinary maintenance	Special maintenance *
1	Door adjustment	1 Year / 1.500 cycles	
	- Gasket replacement	1 Year / 1.500 cycles	
	- Disk-door clearance check	1 Year / 1.500 cycles	
	- Closing force check	1 Year / 1.500 cycles	
	- Lubrication	1 Year / 1.500 cycles	
	- Component wear check	1 Year / 1.500 cycles	
	- Closing pin replacement		4 Years / 10.000 cycles
	- Screw hinge replacement		4 Years / 10.000 cycles
	- Screw tightening		4 Years / 10.000 cycles
2	Calibration / Validation	1 Year	
	- Altitude setting check	1 Year / 1.500 cycles	
3	Filter cleaning / replacement	1 Year / 1.500 cycles	
	- Bacterial filter replacement	6 Months / 500 cycles	
4	Pump feature check	1 Year / 1.500 cycles	
	- Pump replacement		10.000 cycles
5	Tank cleaning	1 Year / 1.500 cycles	
6	Condenser cleaning	1 Year / 1.500 cycles	
7	Safety valve replacement		4 Years / 10.000 cycles

*) To be carried out in *DentalX* service department

In case of direct ship or consign for shipping the sterilizer for service center or factory repairing, include a copy of the filled Service Book pages.

Sterilizer OK YES NO

Date

No. of cycleCleaning cycles

Aborted cycles..... Alarm code

Technician name:

Door adjustment Filter

Calibration Cond. cleaning

Pump Tank cleaning

Notes

.....

.....

.....

.....

.....

Sterilizer OK YES NO

Date

No. of cycleCleaning cycles

Aborted cycles..... Alarm code

Technician name:

Door adjustment Filter

Calibration Cond. cleaning

Pump Tank cleaning

Notes

.....

.....

.....

.....

.....

Sterilizer OK YES NO

Date

No. of cycleCleaning cycles

Aborted cycles..... Alarm code

Technician name:

Door adjustment Filter

Calibration Cond. cleaning

Pump Tank cleaning

Notes

.....

.....

.....

.....

.....

Sterilizer OK YES NO

Date

No. of cycleCleaning cycles

Aborted cycles..... Alarm code

Technician name:

Door adjustment Filter

Calibration Cond. cleaning

Pump Tank cleaning

Notes

.....

.....

.....

.....

.....

Sterilizer OK YES NO

Date

No. of cycle Cleaning cycles

Aborted cycles Alarm code

Technician name:

Door adjustment Filter

Calibration Cond. cleaning

Pump Tank cleaning

Notes
.....
.....
.....
.....

Sterilizer OK YES NO

Date

No. of cycle Cleaning cycles

Aborted cycles Alarm code

Technician name:

Door adjustment Filter

Calibration Cond. cleaning

Pump Tank cleaning

Notes
.....
.....
.....
.....

Sterilizer OK YES NO

Date

No. of cycle Cleaning cycles

Aborted cycles Alarm code

Technician name:

Door adjustment Filter

Calibration Cond. cleaning

Pump Tank cleaning

Notes
.....
.....
.....
.....

Sterilizer OK YES NO

Date

No. of cycle Cleaning cycles

Aborted cycles Alarm code

Technician name:

Door adjustment Filter

Calibration Cond. cleaning

Pump Tank cleaning

Notes
.....
.....
.....
.....

Sterilizer OK YES NO

Date

No. of cycle Cleaning cycles

Aborted cycles..... Alarm code

Technician name:

Door adjustment Filter

Calibration Cond. cleaning

Pump Tank cleaning

Notes
.....
.....
.....
.....

Sterilizer OK YES NO

Date

No. of cycle Cleaning cycles

Aborted cycles..... Alarm code

Technician name:

Door adjustment Filter

Calibration Cond. cleaning

Pump Tank cleaning

Notes
.....
.....
.....
.....

Sterilizer OK YES NO

Date

No. of cycle Cleaning cycles

Aborted cycles..... Alarm code

Technician name:

Door adjustment Filter

Calibration Cond. cleaning

Pump Tank cleaning

Notes
.....
.....
.....
.....

Sterilizer OK YES NO

Date

No. of cycle Cleaning cycles

Aborted cycles..... Alarm code

Technician name:

Door adjustment Filter

Calibration Cond. cleaning

Pump Tank cleaning

Notes
.....
.....
.....
.....



DENTAL X S.p.A.
Via Marzotto 11
36031 Dueville (VI) Italy
Tel. +39 0444 367400
Fax +39 0444 367436
e-mail: dentalx@dentalx.it
<http://www.dentalx.it>